

1 FLOOR PLAN

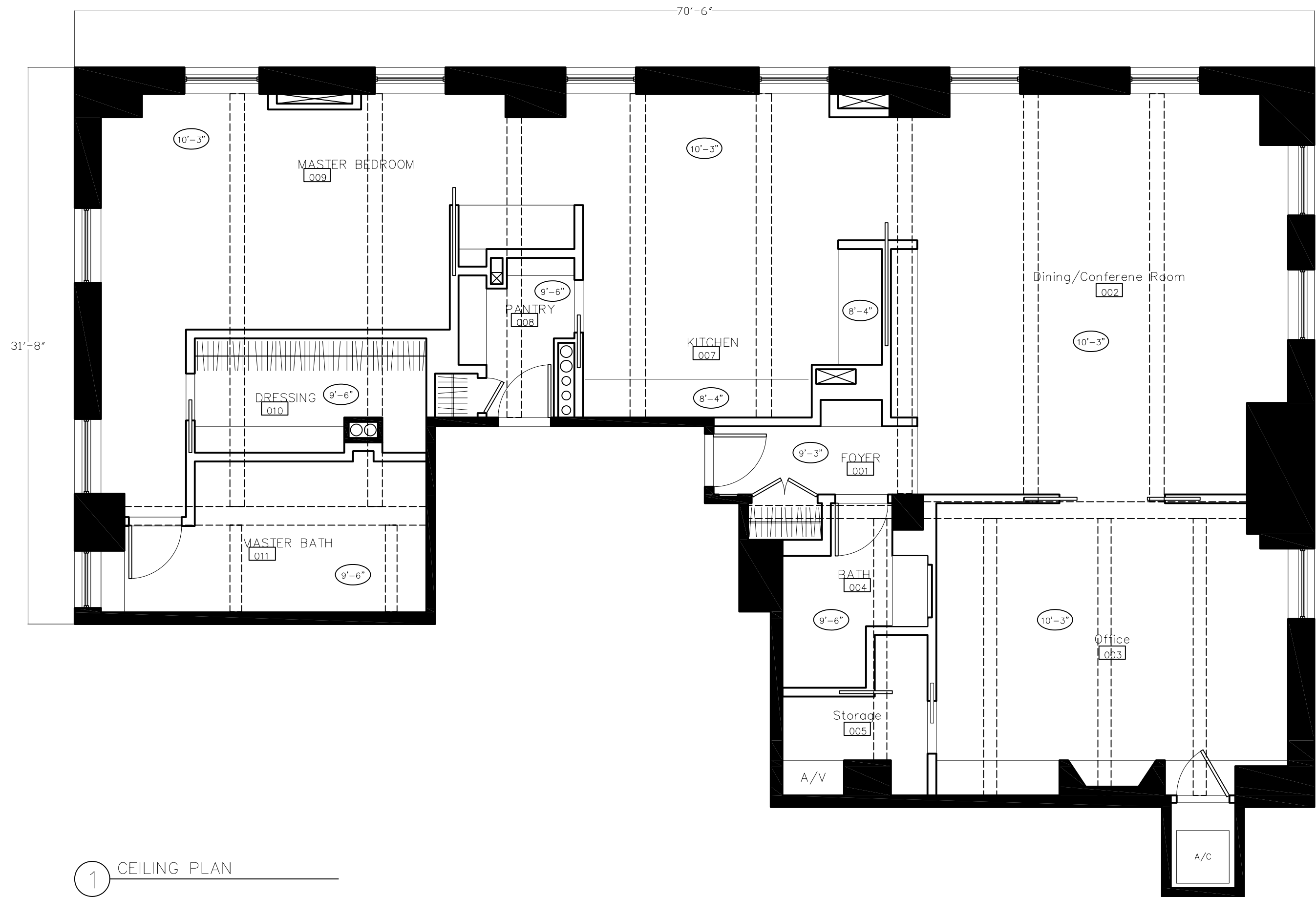

1 CEILING PLAN

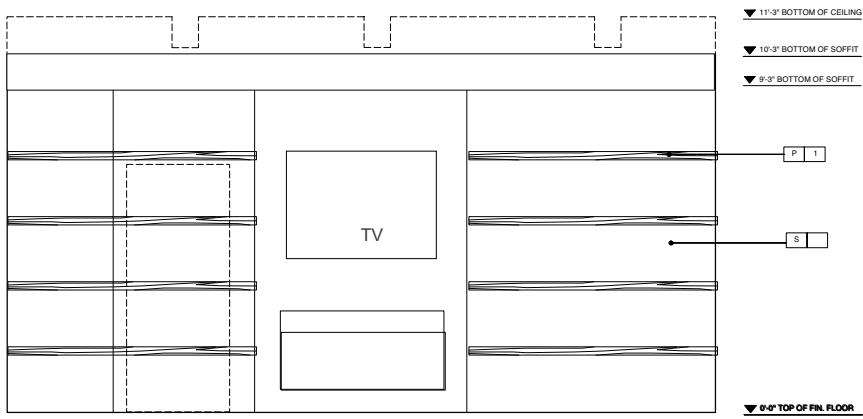

1 OFFICE ELEVATION

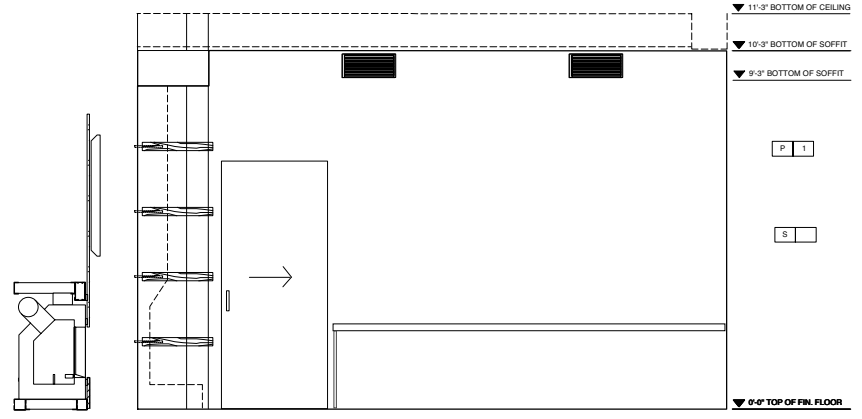

2 OFFICE ELEVATION

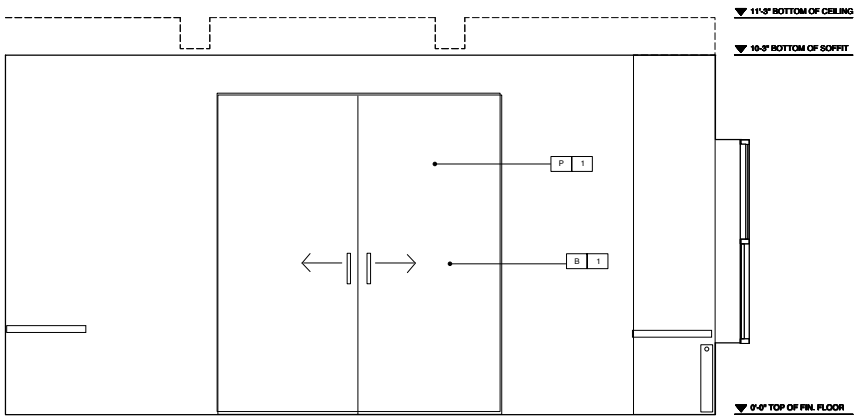

3 OFFICE ELEVATION

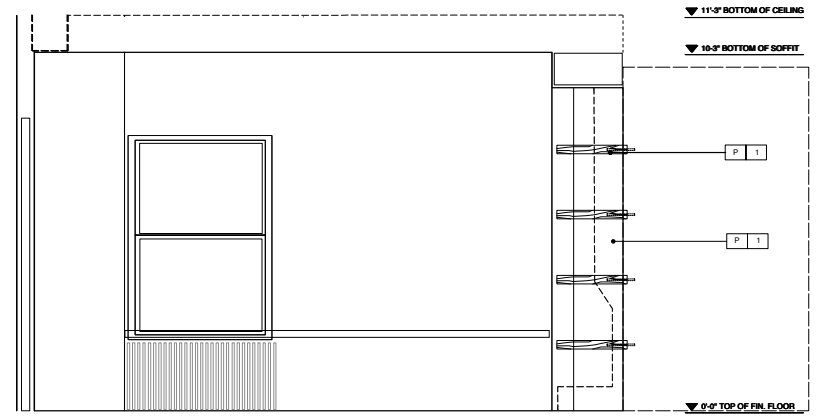

4 OFFICE ELEVATION

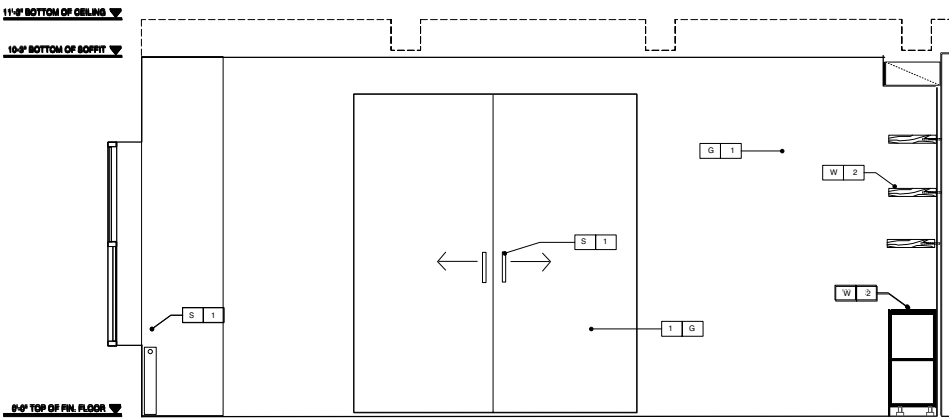

5 CONFERENCE ROOM ELEVATION

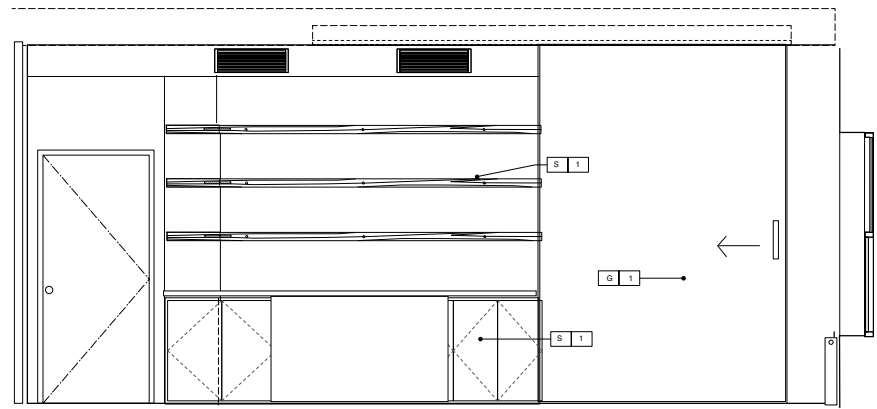

6 CONFERENCE ROOM

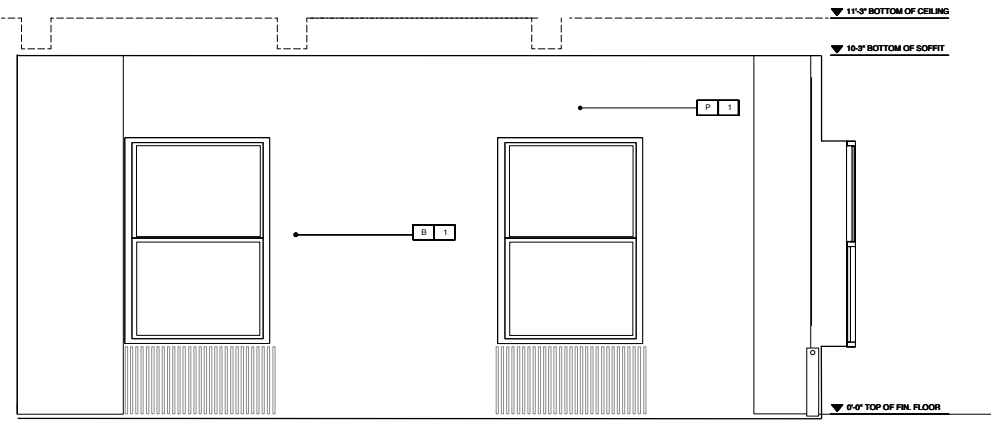

7 CONFERENCE ROOM ELEVATION

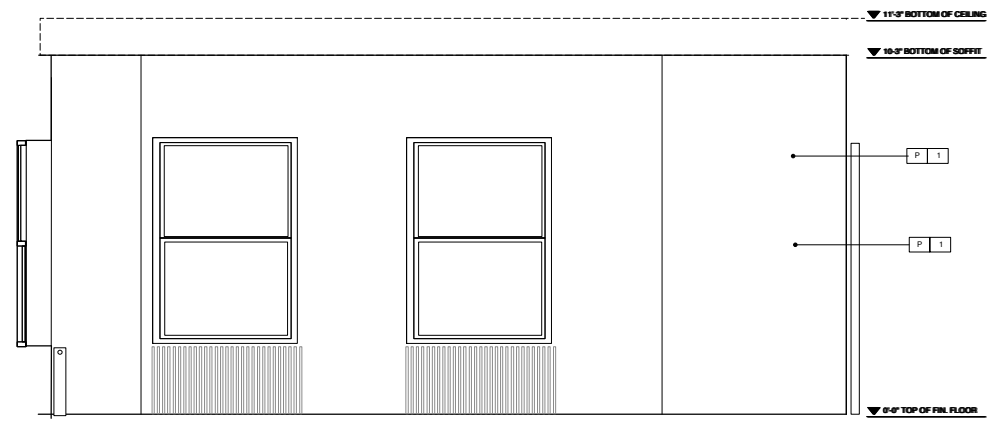

8 CONFERENCE ROOM ELEVATION

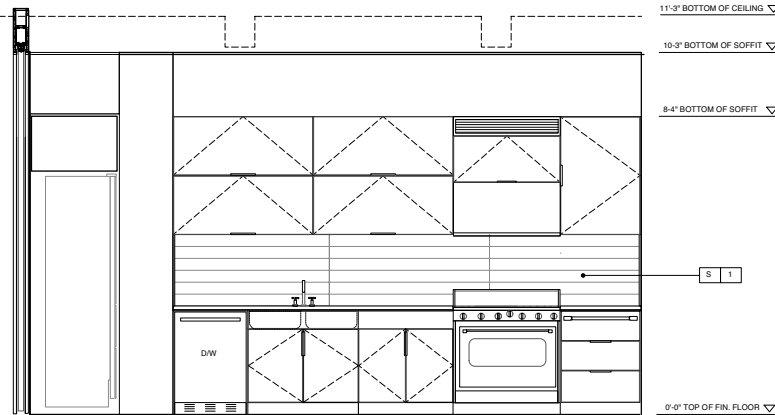

3 KITCHEN ELEVATION

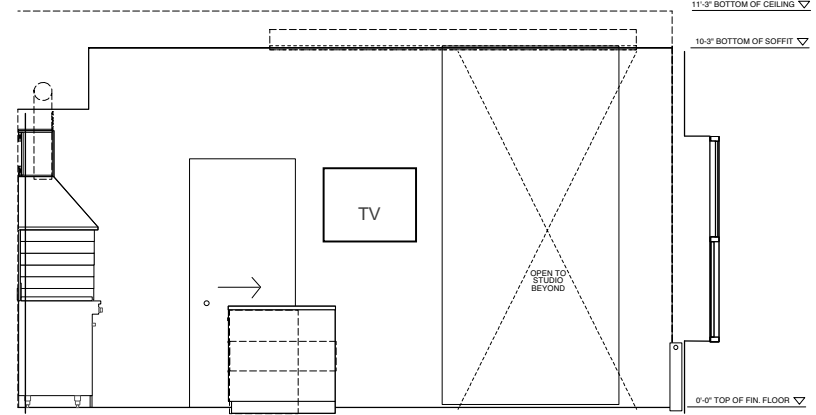

3 KITCHEN ELEVATION

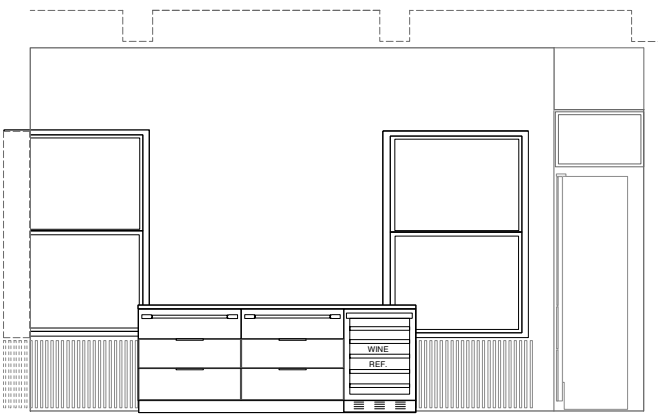

3 DINING ELEVATION

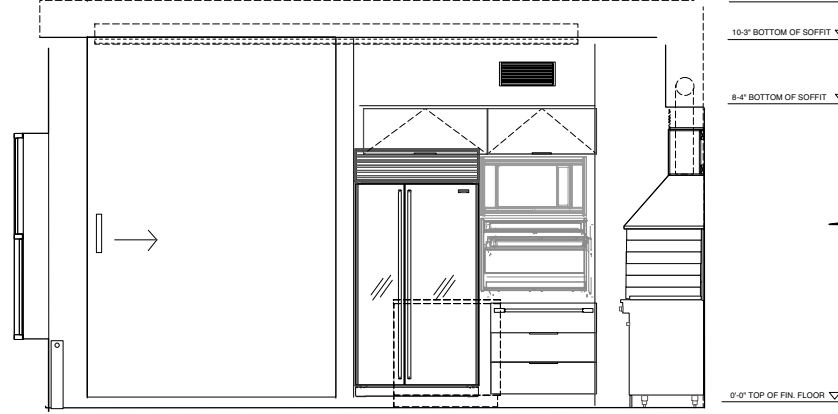

3 KITCHEN ELEVATION

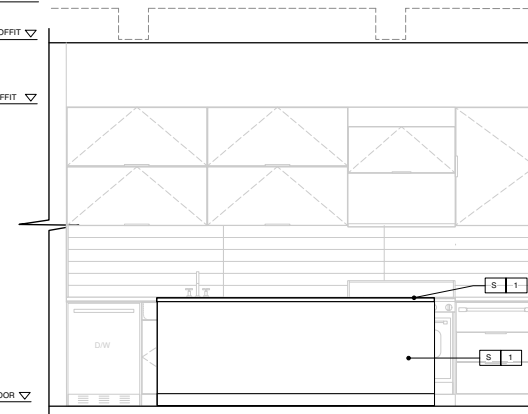

3 KITCHEN ELEVATION

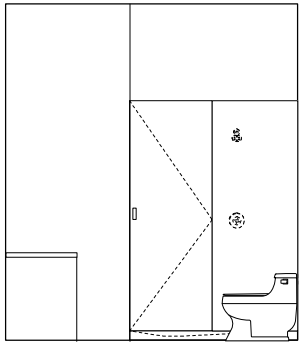

2 GUEST BATH ELEVATION

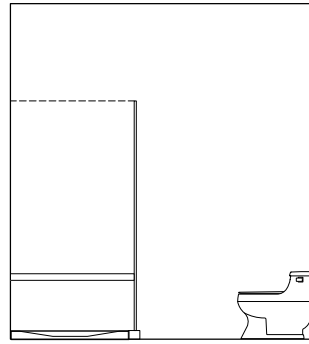

3 MASTER BATH ELEVATION

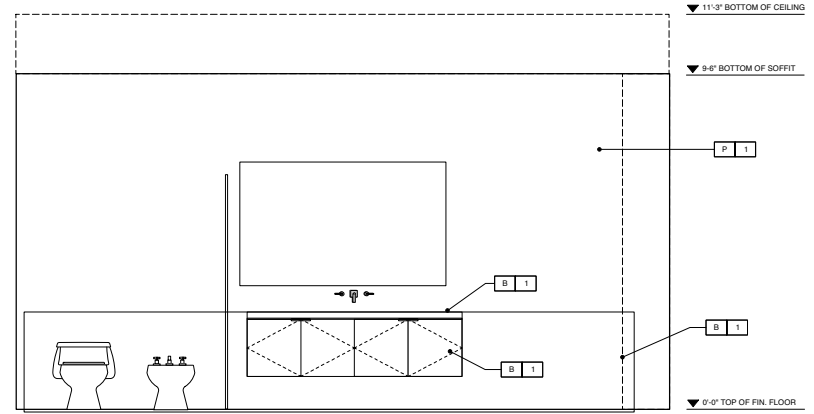

3 MASTER BATH ELEVATION

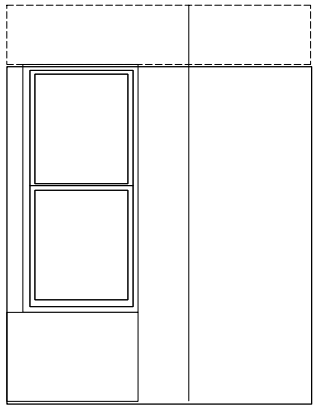

3 GUEST BATH ELEVATION

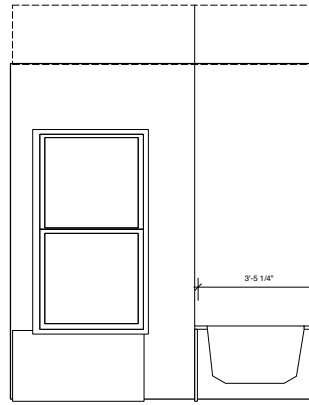

3 MASTER BATH ELEVATION

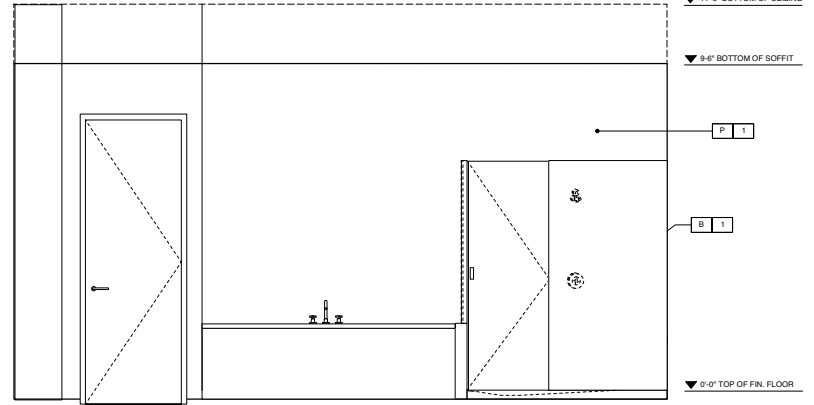

4 MASTER BATH ELEVATION

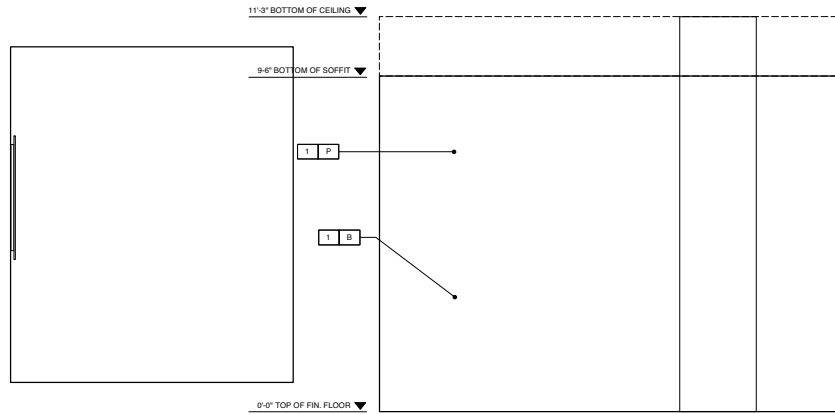
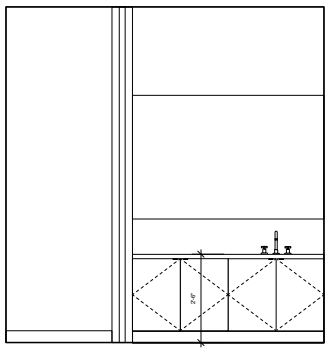

DRESSING ROOM ELEVATION 3

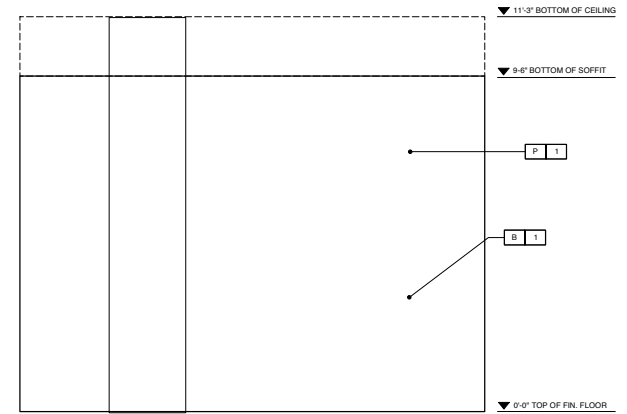

3 DRESSING ROOM ELEVATION